



# 2901

hand-drawn

for sheers, light and medium-weight curtains

**One rail, many possibilities**

# 2901



## hand-drawn

for sheers, light and medium-weight curtains

## versatile & discreet

The Qurails 2901 rail you can create a perfect overlap, because of the low profile height of 8 mm, the track is barely visible. In addition, it is easy to install and is often used as a return for wider profiles of the 2900 series. The rail has two parallel running rail channels, for a sleek look. The rail can be used in private homes or in projects.

- The ideal track for combining sheers and lightweight or medium-weight curtains.
- Easy to bend and exceptional quality.
- Suited for ceiling or wall mounting
- Silent and smooth running.



### Standard colours



High quality, wear-resistant coating, highly colourfast, UV-resistant.  
Other RAL colours & special coatings on request.

### Features

Material:	aluminium
Colour:	white
Dimensions:	8 x 40 mm
Weight profile:	274 gr/m
Mounting:	ceiling or wall

## Profile/ gliderspecifications

### Aluminium profile:

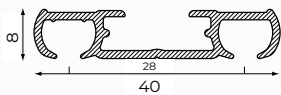

### Glider:

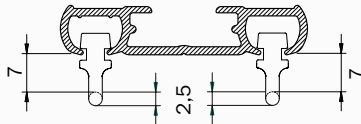

### Colours with RAL code and lengths (m):

	RAL	4	5	6	7
white	9010			•	

### Mounting surface:

- wood
- masonry/concrete

### Bracket type:

- screw mounting
- extension bracket

### Bending:

bendingradius	bending tool
R 20 cm	1015
R 25 cm	1015
R>150 cm	1018

--	--

## Specification guide

### Material

- Aluminium EN AW-6060-T66.
- Powder coated in accordance with the Qualicoat standard.

## Mounting

Ceiling mounting of a pre-punched 2901 by Qurails with 2914-WD screws with white caps.

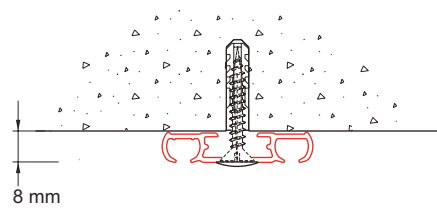

Wall fixing 2901 with extension bracket 2917-09

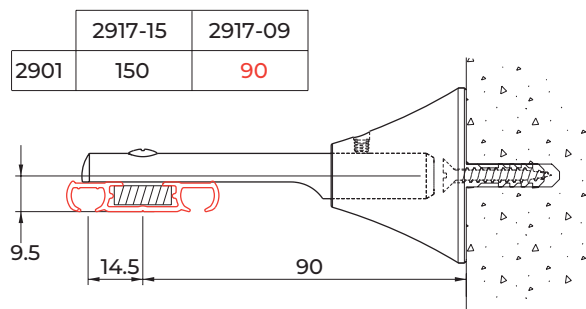

### Mounting guideline

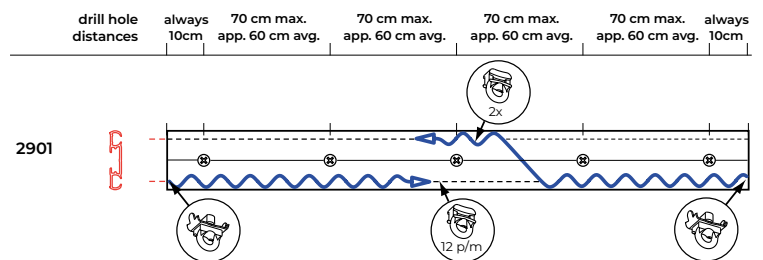

The distance between the brackets can vary depending on the following factors: the mounting surface (wood, concrete or plaster), the weight of the curtains and the curtain fabric production method, the specific application and the system usage intensity. General advice: with the curtains open, place additional brackets where the pleats bunch together. Also place additional brackets before and after bends.

Advice mounting clip: max. every 30 cm.

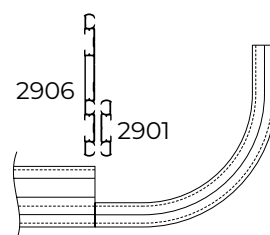

Kombination aus den breiten Profilen 2905 und 2906 mit 90-Grad-Retoure 2901-R-W und 2 Kanälen mittels Schienenverbinder 2952



## Standard parts

### Curtain transport



2001  
twist end stop  
white / grey / black

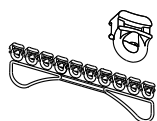

2010  
glider  
white / grey /  
black

### Mounting



2254  
clip white  
(for light curtains  
only)



2914  
screw with  
white cover

### Accessories

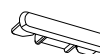

2953-01  
end cap white

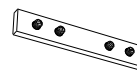

2952  
connecting bridge  
natural

## Optional parts

### Curtain transport



2001-50-M-N  
end stop with eye  
metal natural

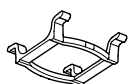

2004  
brake glider  
white / grey / black

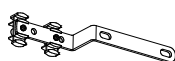

4074-1000  
carrier with overlap,  
a.o. for draw rod  
white / natural metallic  
/ black

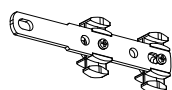

4075-1000  
carrier without overlap,  
a.o. for draw rod white  
/ natural metallic /  
black



2010-50  
glider 2010 with  
hook 2023 white



2010-60  
glider 2010-W  
with SS hook  
white



2012-50  
click-in glider  
with hook  
white



2012  
double hook  
white



2020  
G-Hook  
white



2021-FL  
curtain hook  
white



2022  
curtain hook  
white



2023  
curtain hook  
white



2024-55  
adjustable sew  
in hook white  
55mm



2024-95  
adjustable sew  
in hook white  
95mm

### Accessories

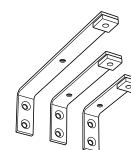

2915  
extension bracket  
7,5, 10, 15 cm  
white / natural metallic

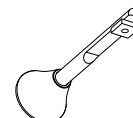

2917  
adj. extension bracket  
9 - 15 cm white / natural  
metallic



2901-R  
curve 90 degree R20  
return + 2952  
white



KVT-TI  
draw rod 100, 125, 150,  
200 of 300 cm white  
/ natural metallic /  
black / transparent

Technical specifications are subject to  
change without prior notice.

# Qurails®

Open a new experience