



4200

hand-drawn

for light, medium- and heavy-weight curtains

Elegant track with a high level of comfort

4200



hand-drawn

for light, medium- and heavy-weight curtains

elegant & versatile

The Qurails 4200 track has the looks of a classic curtain pole, but it offers the comfort of a curtain rail. The curtains glide smoothly virtually without sound. It can be easily mounted in various ways on a wall or ceiling. A very popular track that can be used in a wide variety of situations, such as private homes, but also in office buildings and in the care sector.

- The ideal track for lightweight, medium-heavy or heavy curtains.
- Easy to bend and exceptional quality.
- Can be forward or reverse bent in different radii.
- Compatible with the Goelst Flow System for regularly pleated curtains.
- Silent and smooth running, also round bends.
- Compatible with LRS gliders.



Standard colours

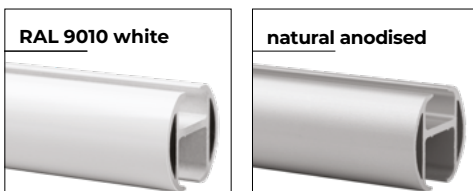

High quality, wear-resistant coating, highly colourfast, UV-resistant.
Other RAL colours & special coatings on request.

Features

Material:	aluminium
Colour:	white, natural anodised
Dimensions:	18 x 21 mm
Weight profile:	274 gr/m
Mounting:	wall or ceiling

Profile/ gliderspecifications

Aluminium profile: Glider:

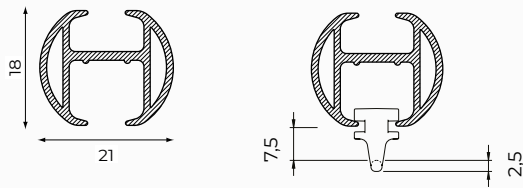

Colours with RAL code and lengths (m):

	RAL	4	5	6	7
white	9010			•	
natural				•	

Mounting surface:

- wood
- masonry/concrete

Bracket type:

- ceiling bracket
- wall bracket
- spacer bracket

Bending:

bending radius	bending tool
R 15 cm	1015
R 25 cm	1015
R > 100 cm	1018

R 15 cm

R > 100 cm

Flow

The Qurails Flow System keeps pleats in curtains consistent. It can be used with small and wide channel tracks and, because of the broad assortment of components, it can be integrated in hand-drawn, cord-pulled and electrically operated systems.

The Flow System can also be used with curved curtain tracks. For further information, [see the Flow product data sheet](#).

Bestekomschrijving

Materiaal

- Aluminium EN AW-6060-T66.
- Anodised in accordance with the Qualanod standard.
- Powder coated in accordance with the Qualicoat standard.

Mounting



Ceiling mounting 4200 with bracket 5135

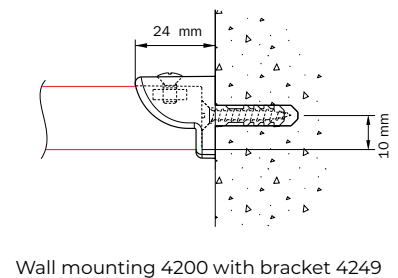
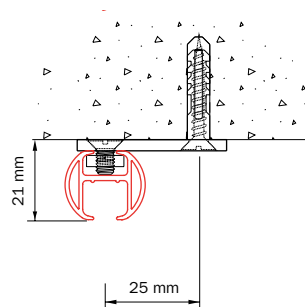

Wall mounting 4200 with bracket 4249

Wall mounting with adjustable extension bracket 4217-101; bracket can be shortened to x = 50mm

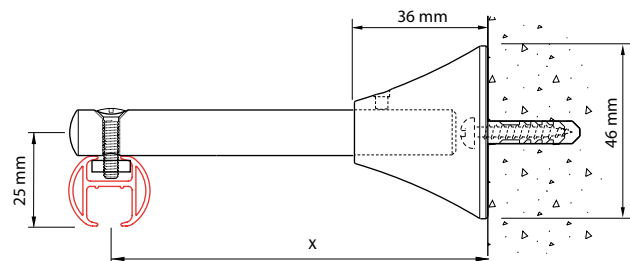

Mounting guideline

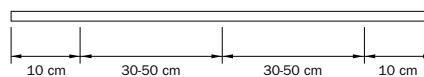

The distance between the brackets can vary depending on the following factors: the mounting surface (wood, concrete or plaster), the weight of the curtains and the curtain fabric production method, the specific application and the system usage intensity. General advice: with the curtains open, place additional brackets where the pleats bunch together. Also place additional brackets before and after bends.



Standard parts

Curtain transport



4001
end stop
white / grey / black

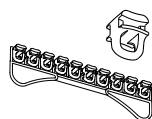

4010
glider
white / grey / black

Montage

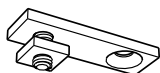

5135
ceiling bracket
white / grey /
black

Accessoires



4253
plastic eindcap
white / grey



5152
connecting bridge
natural

Optional parts

Curtain transport

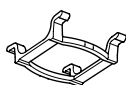

2004
brake glider
white / grey / black



4001-M-N
end stop metal
with eye natural



4002
end stop metal



4003
spring stop
plastic requires
punch hole



4007
rotating glider
white / grey / silver /
black



4007-LRS
rotating glider LRS
grijs / rotating glider
LRS red



4010-50
glider white with
hook 2023



4012
click-in glider white



4020
heavy duty glider
white / grey / black



4030
roller
white / black

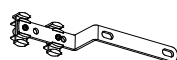

4074-1000
carrier with overlap,
a.o. for draw rod
white / natural
metallic / black

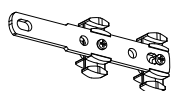

4075-1000
carrier without
overlap, a.o. for draw
rod white / natural
metallic / black



6010
projection glider
white / grey / black



2020
double hook
white



2021
G-Hook white



2022
curtain hook
white



2023
curtain hook
white



2024-55
adjustable sew in
hook white
55mm

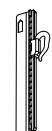

2024-95
adjustable sew in
hook white
95mm

Mounting



4254
mini suspension hanger,
white, natural, black



4249
adj. ext. bracket
white / grey



5140
wall bracket
white / grey / black

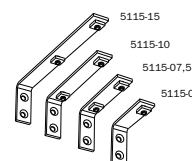

5115
extension bracket
5, 7.5, 10, 15 cm
white / natural metallic
/ black

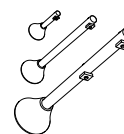

4217
adj. extension bracket
10 cm, 1 hole
20 cm, 1 hole
20 cm, 2 holes
white / natural metallic /
black

Accessories



4253-A
aluminium end cap
white / natural metallic



4048-10MM
corner connection



1220
draw rod 100, 125, 150,
200 or 300 cm white /
natural metallic / black

Technical specifications are subject to change without prior notice.

Qurails®

Open a new experience