



# 4701

hand-drawn

for light and medium-weight curtains

---

**Compact and sleek**

# 4701



## hand-drawn

for light and medium-weight curtains

### Compact and sleek

The Qurails 4701 track is a pretty rectangular profile. This curtain track is usually recessed into a wooden surface. An attractive, sleek track that can be used in your home or office building.

- The ideal track for sheers and lightweight or medium-heavy curtains.
- Easy to bend and exceptional quality.
- Can be forward or reverse bent in different radii.
- Concealed mounting on wood by screw or on concrete by ceiling bracket
- Compatible with the Qurails Flow System for regularly pleated curtains.
- Silent and smooth running, also round bends.



### Standard colours

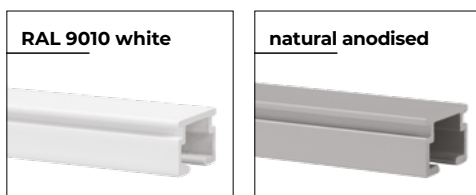

High quality, wear-resistant coating, highly colourfast, UV-resistant.  
Other RAL colours & special coatings on request.

### Features

Material:	aluminium
Colour:	white, natural anodised
Afmetingen:	10 x 15 mm
Weight profile:	137 gr/m <sup>1</sup>
Mounting:	ceiling



## Profile/ gliders specifications

### Aluminium profile: Glider

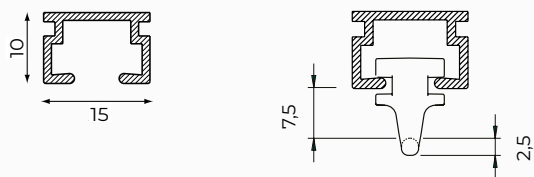

### Colours with RAL code and lengths (m):

4701 and 4701-PB PB with punch type 'B':

	RAL	4	5	6	7
white	9010			•	
natural				•	

Other punch types or colours on request.

### Mounting surface:

- wood
- masonry/concrete

### Bracket type:

- ceiling bracket

### Bending:

bending radius	bending tool
R 10 cm	1012
R 10 cm	1015
R > 80 cm	1018

R 10 cm

R > 80 cm

## Flow

The Qurails Flow System keeps pleats in curtains consistent. It can be used with small and wide channel tracks and, because of the broad assortment of components, it can be integrated in hand-drawn, cord-pulled and electrically operated systems.

The Flow System can also be used with curved curtain tracks. For further information, [see the Flow product data sheet](#).

## Specification guide

### Material

- Aluminium EN AW-6060-T66.
- Anodised in accordance with the Qualanod standard.
- Powder coated in accordance with the Qualicoat standard.

## Mounting

Pre-punched track from the 4700 series mounted using cross-head screws 2314

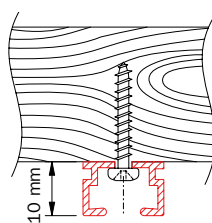

Mounting 4701 with metal ceiling bracket 4750

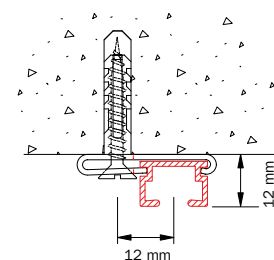

Mounting milled rail

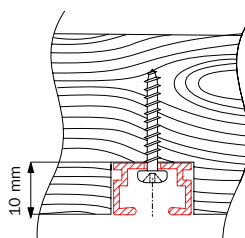

## Punch types

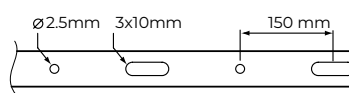

### Additional mounting options

Standard punched hole type B. (Ø2.5 + 3 x 10 mm slot, every 15 cm)  
Other punch types are available on request.

## Application example

4701 with end cap 4753-12

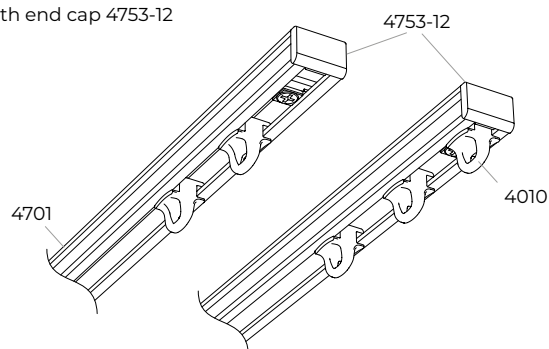

Application of the 4753-12, a product with two functions: only as end cap or as end cap and end stop.

### Mounting guideline (based on ceiling bracket)



The distance between the brackets can vary depending on the following factors: the mounting surface (wood, concrete or plaster), the weight of the curtains and the curtain fabric production method, the specific application and the system usage intensity. General advice: with the curtains open, place additional brackets where the pleats bunch together. Also place additional brackets before and after bends.



## Standard parts

### Curtain transport

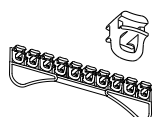

4010  
glider  
white / grey / black

### Mounting

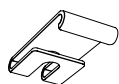

4750  
ceiling bracket  
white / natural



2314  
Pozi-drive screw  
for ceiling fixing 19  
mm white / natural  
metallic / black

### Accessories

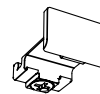

4753-12  
end cap  
white / grey

## Optional parts

### Curtain transport

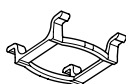

2004  
brake glider  
white / grey / black



4001-M  
end stop metal  
with eye natural



4002-M  
end stop metal



4003  
spring stop plastic  
requires punch hole  
white



4007  
rotating glider white/  
grey / silver / black



4007-LRS  
rotating glider LRS  
grijs / rotating glider  
LRS red



4010-50  
glider white with  
hook 2023



4012  
click-in glider white

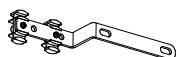

4074-1000  
carrier with overlap,  
a.o. for draw rod  
white / natural  
metallic / black

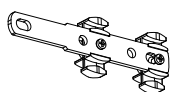

4075-1000  
carrier without  
overlap, a.o. for  
draw rod white /  
natural metallic /  
black



2020  
double hook  
white



2021  
G-Hook  
white

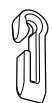

2022  
curtain hook  
white



2023  
curtain hook  
white



2024-55  
adjustable sew  
in hook white  
55mm



2024-95  
adjustable sew  
in hook white  
95mm

### Accessories



4048-08MM  
corner  
connection

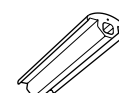

4145  
flexible dust cover



KVT-T1  
draw rod 100, 125, 150,  
200 of 300 cm white /  
natural metallic / black  
/ transparent

Technical specifications are subject  
to change without prior notice.

**Qurails**<sup>®</sup>  
Open a new experience