

4100



mounting ceiling, wall & blind

profile

4100
405 gr/m

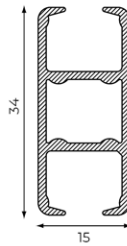

bending

radius cm
R 15 (1015)
R 20 (1015)
R 30 (1015)
R >80 (1018)

filler position

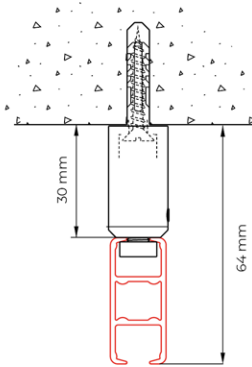
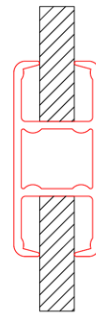

ceiling mounting with mini suspension hanger 4254

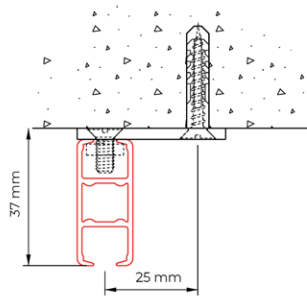

ceiling mounting with ceiling bracket 4135

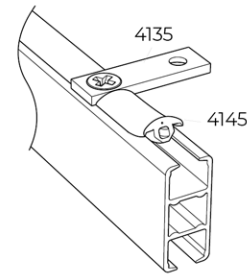

ceiling mounting with ceiling bracket 4135 and dust cover 4145 to seal the gap

wall mounting with extension bracket 4217

in mm	a
4217-101	100
4217-201	200
4217-202	200

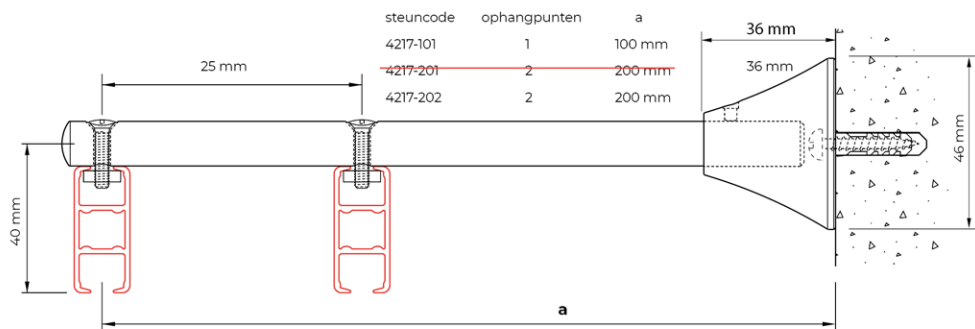

wall mounting with wall bracket 4149

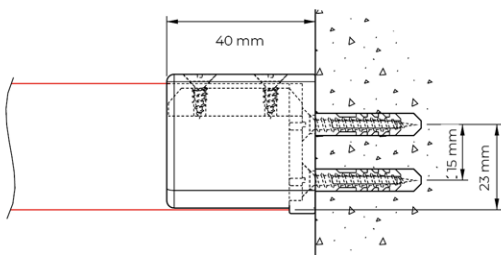

wall mounting with extension brackets 4115

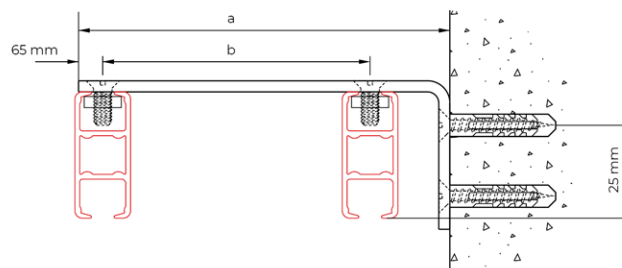

in mm	a	b
4115-07.5	75	47
4115-10	100	72
4115-15	150	72

Application example

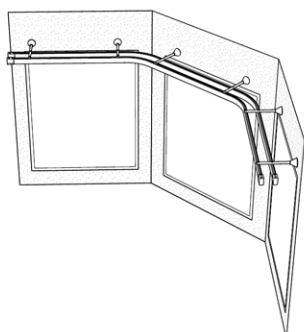

G-Norm

