

4200



mounting ceiling & wall

profile

4200 Douche

274 gr/m

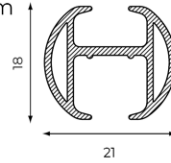

bending

radius cm

R 15 (1015)

R 25 (1015)

R >100 (1018)

filler position

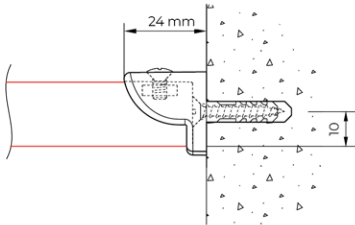
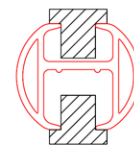

wall mounting 4200
with wall bracket 4249

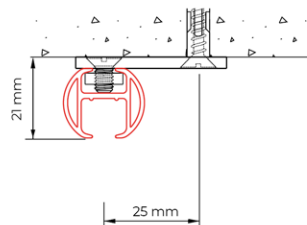

ceiling mounting 4200
with ceiling bracket 5153

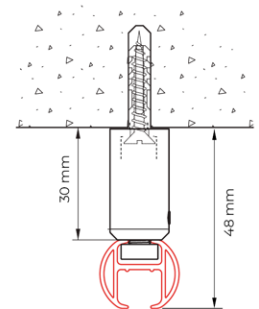

ceiling mounting 4200
with suspension hanger

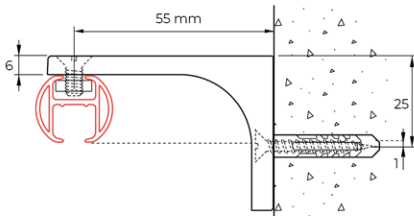

wall mounting 4200
with wall bracket 5140

Suspension hangers

ceiling mounting 4200:

threaded rod set 4055-10, suspension hanger tube 4055-40 and with mounting set 4055-30.

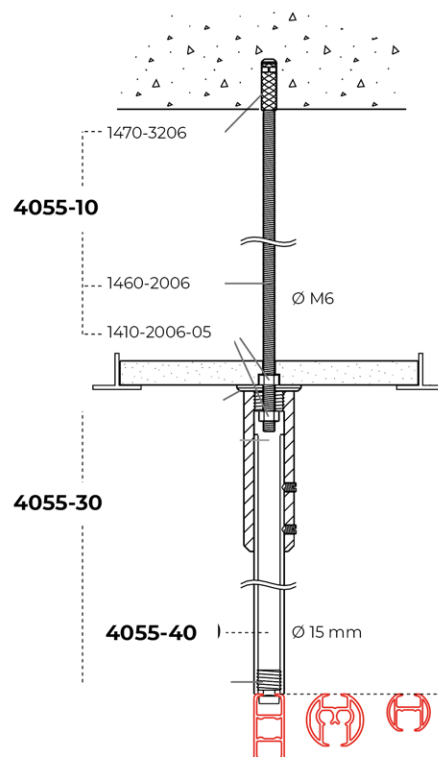

Application examples

standard shower rail situations and suspension hanger

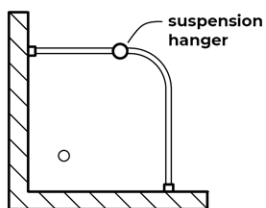

L-shaped (shower)

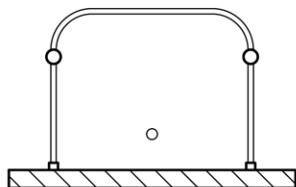

U-shaped (shower)

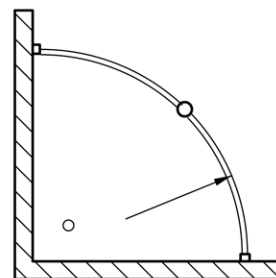

special (for example corner baths)

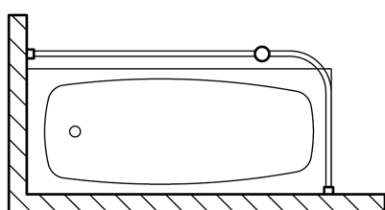

L-shaped (bath)

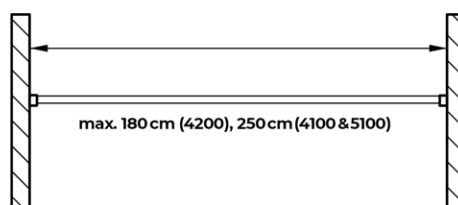

straight rail

max. 180 cm (4200), 250 cm (4100 & 5100)

G-Norm

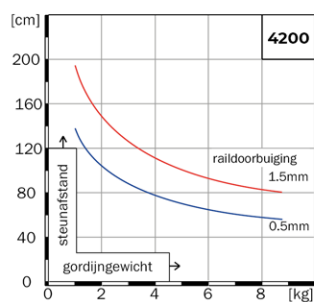

IEC 60364

IEC 60364 is a standard for o.a. isolated rail mounting. For further information please contact Qurails in Ede, The Netherlands