

# 5100



## mounting ceiling, wall & blind

### profil

5100 Cord operated  
522 gr/m

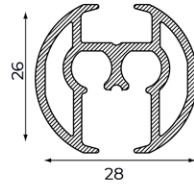

### buigen

radius cm  
R 15 (1015)  
R 25 (1015)  
R >100 (1018)

filler position

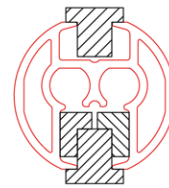

L-shaped fillers only for  
cord operated systems

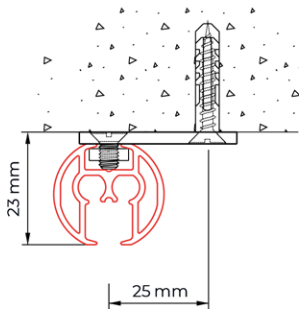

ceiling mounting 5100  
with ceiling support 5135

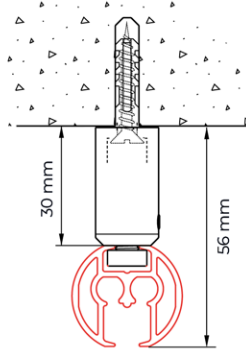

ceiling mounting 5100 with  
mini suspension hanger 4254

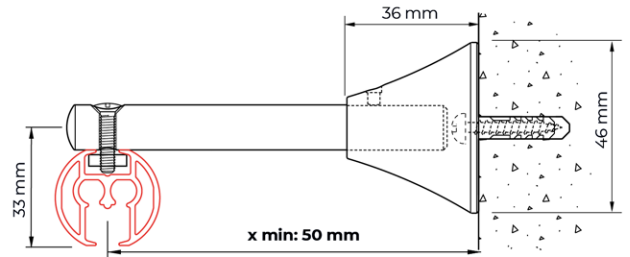

wall mounting 5100 with adaptable extension bracket  
4217-101, bracket can be cut back to x=50mm.

|          | x (mm) | x min. (mm) |
|----------|--------|-------------|
| 4217-101 | 100    | 50          |
| 4217-201 | 200    | 50          |
| 4217-202 | 200    | 50          |

## Exploded view

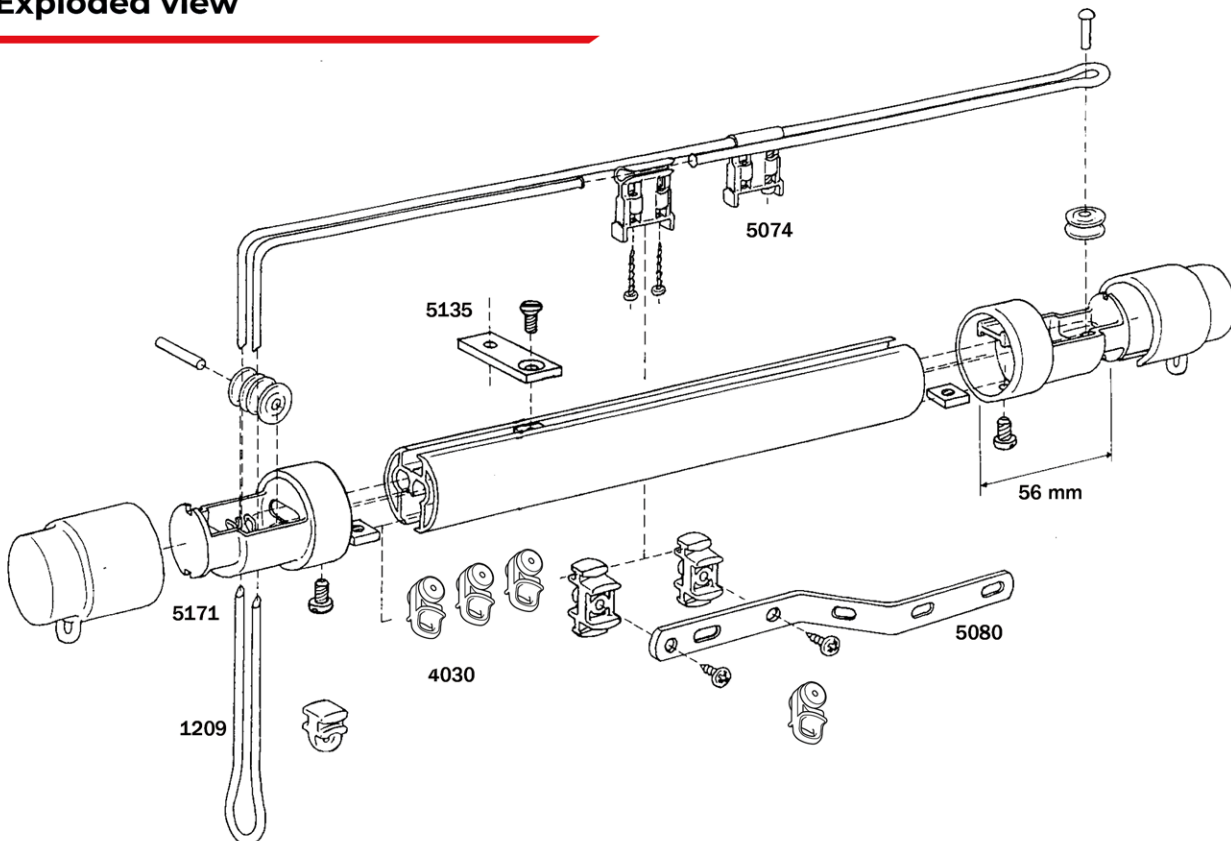

## load table

(max. curtain weight in kg)

5100

| curves          | glider/roller    | tot 6 m |
|-----------------|------------------|---------|
| <b>straight</b> | 4010, 4020, 4030 | 30      |
|                 | 6010             | 20      |
| <b>1 curve</b>  | 4010, 4020, 4030 | 20      |
|                 | 6010             | 15      |
| <b>2 curves</b> | 4010, 4020, 4030 | 15      |
|                 | 6010             | 10      |

## Application example

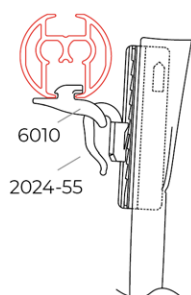

heading with projection  
glider 6010

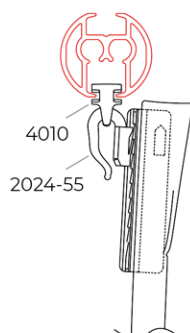

without heading with  
glider 4010

Thanks to the projection of glider 6010, a heading can be created in a round rail without the rail pushing it outward.

## G-Norm

